

**RP78891▲**  
Hose & Sprayer Assembly  
Juego de Manguera y Rociador  
Tuyau souple et douchette

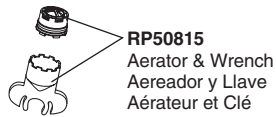

**RP50815**  
Aerator & Wrench  
Aereador y Llave  
Aérateur et Clé

**RP77552▲**  
Trim Ring and Gasket  
Aro de Accesorio y Empaque  
Anneau de finition et Joint

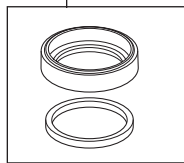

**RP73000**  
Cartridge Assembly  
Ensamble de la válvula  
Soupape

**RP54975**  
O-Ring  
Anillo "O"  
Joint torique

**RP77551▲**  
Button  
Botón  
Bouton

**RP72998**  
Screw  
Tornillo  
Vis

**RP61043**  
Bonnet Nut  
Bonete  
Chapeau

**RP54972▲**  
Cap  
Casquete  
Embase

**RP77550▲**  
Handle, Set Screw &  
Button  
Manija, tornillo de presión  
y Botón  
Poignée, Vis de calage et  
Bouton

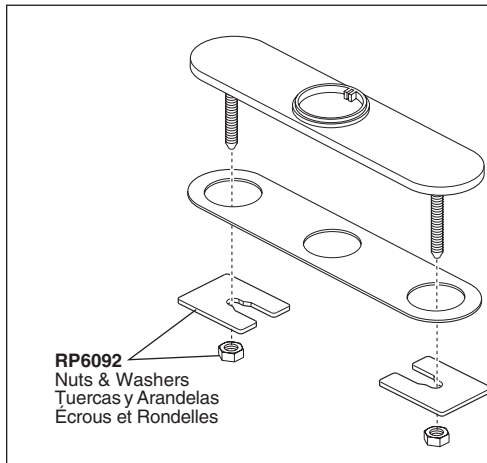

**RP6092**  
Nuts & Washers  
Tuercas y Arandelas  
Écrous et Rondelles

**RP71451▲**  
Optional 10" Escutcheon with 8" Centers,  
Mounting Screws and gasket  
Chapa opcional de 10" de 8" centros,  
Tornillos para la Instalación y Empaque  
Plaque de finition facultative de 10 po pour  
8 po centres, vis de montage, écrous, ron-  
delles et joint

**RP51685**  
Mounting Bracket &  
Nut  
Abrazadera para  
la Instalación y  
Tuerca  
Fixation et écrou

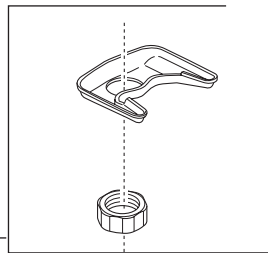

**RP40531**  
Wrench  
Llave  
Rondelle

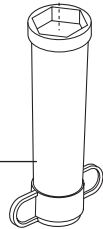

**RP51243**  
Inlet Gaskets  
Empaques para el tubo de entrada  
Joints côté alimentation

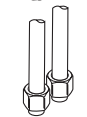

**RP50952**  
Cut-To-Fit Plastic Sleeves  
Casquillos cortados a la medida  
Bagues d'extrémité pour tubes coupés

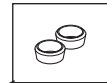

**RP60911**  
Clip  
Presilla  
Agrafe



**RP37490**  
Thin Deck Aid  
Sostén para Bordes Delgados  
Plaque de renfort

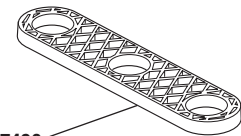

▲Specify Finish  
▲Especifíque el Acabado  
▲Précisez le Fini